

BRIAN JAMES TRAILERS

» Connected to you

CARGO CONNECT

Configure on demand, meet changing needs.

UNITED KINGDOM

CARGO CONNECT

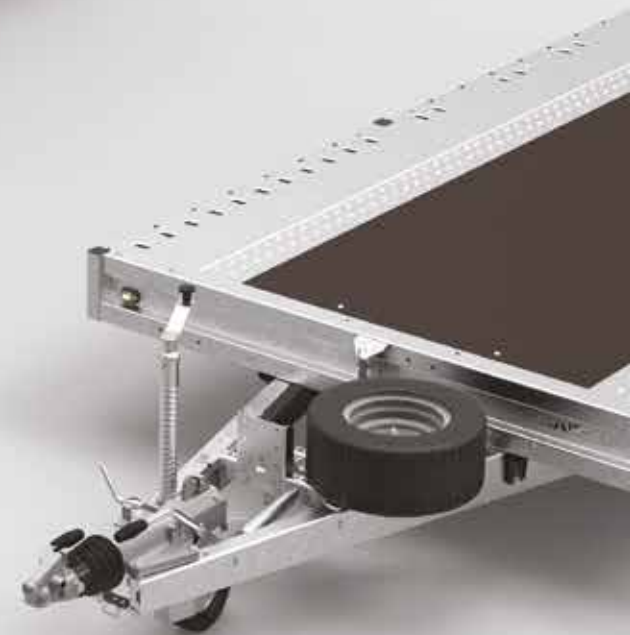

CARGO CONNECT

Commercial trailer transport solution.

5 5 YEAR
CHASSIS
WARRANTY

CarGO Connect is the most adaptable commercial goods and vehicle transport trailer. To provide complete flexibility a whole host of new and unique solutions allow re-configuration on demand. Every available option can be added or removed at anytime, from brand new, or whenever required in the future.

As well as a uniquely configurable concept, CarGO Connect sets new standards in trailer engineering quality and value for money. The resulting longevity of chassis and components will continue to deliver results well into the future.

Platforms sizes are offered from 4.0m through to 5.5m long, in two standard widths. Several axle and wheel size combinations are available to provide almost any required solution, including a new heavy duty 195/60 R12 tyre option.

Professional sales and after-sales support is available through an extensive network of dedicated Brian James Trailers dealers, able to supply to your exact requirements, when you need them to.



CONNECT.

CARGO CONNECT

CLICK AND CONNECT, standard features everywhere .

At the heart of the CarGO Connect is a redefinition of a multi-purpose trailer. It means any available option can be added or removed to suit, as and when needed. CarGO Connect is certainly defined by the concept of configuration, but in addition this brand new design is completed by a multitude of new features and ideas specifically to assist users gain flexibility and easy operation.

As highlighted on this and the facing page, the standard features ensure that CarGO Connect can be just as competent loading and transporting super-cars, as tractors, mowers or heavy pieces of equipment. This is the professionals trailer.

● Multiple anchor points

Numerous strap attachment points are provided along each side of CarGO Connect. Each are located through the chassis providing ultimate strength. For vehicle transport a set of professional wheel 'sling' straps can be used for maximum security. Machine movement is made easy with many tie-down options.



● LED marker lamps
LED technology, super-bright and reliable lamps are fitted in front (white), sides (amber) and rear outline marker (red/white/amber) positions as well as for registration plate illumination.

● Underside rope hooks

All along the underside many convenient rope hooks are provided.

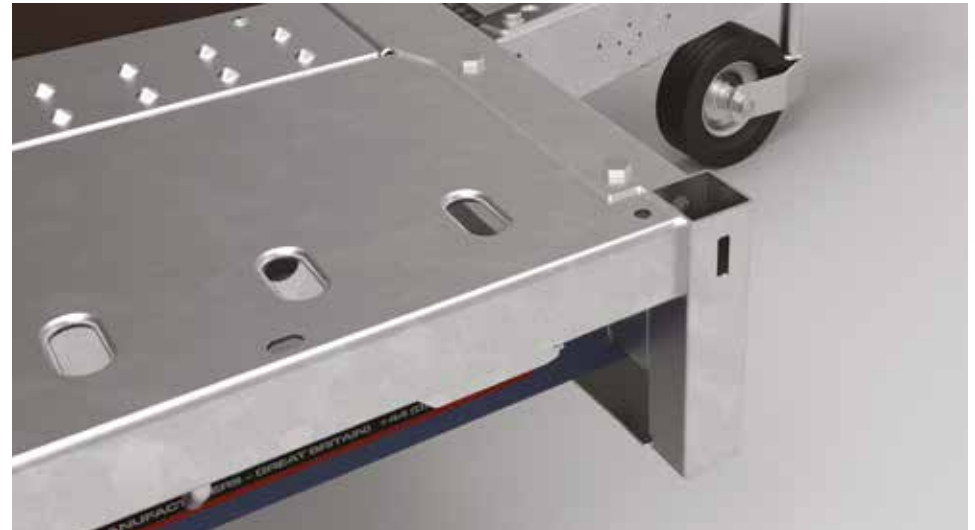

● Connected

In every corner of the CarGO Connect chassis and placed at points in-between are high strength 'Connect Nodes'. Each node represents the ability to click into place a variety of posts for options such as side systems, headboards or ladder racks. No tools, no fuss.



● Individual lamp array

Stylish, well protected lamps are individually replaceable in the unlikely event of damage. They feature a high quality bulb holder providing durability and a convenient twist release mechanism for easy bulb access. The fully sealed lamps are further protected by a bodywork housing preventing direct wheel spray. CarGO Connect features a junction box wiring system for easy maintenance.



● **Smooth-ride, self damping**
CarGO Connect trailers are designed for long distance and heavy loads. Axles and suspension technology is by AL-KO, Europe's largest trailer equipment manufacturer.

With extensive in-house testing and development facilities in Germany and a history of over 80 years, AL-KO are able to provide an unmatched combination of competence and experience.

CarGO Connect offers the choice of either a 10" or 12" wheel / tyre size. Choose 10" for the best in low-loading or 12" when a super heavy-duty performance is a priority.

Several combinations of either twin or tri-axle extend the range to meet any requirement.

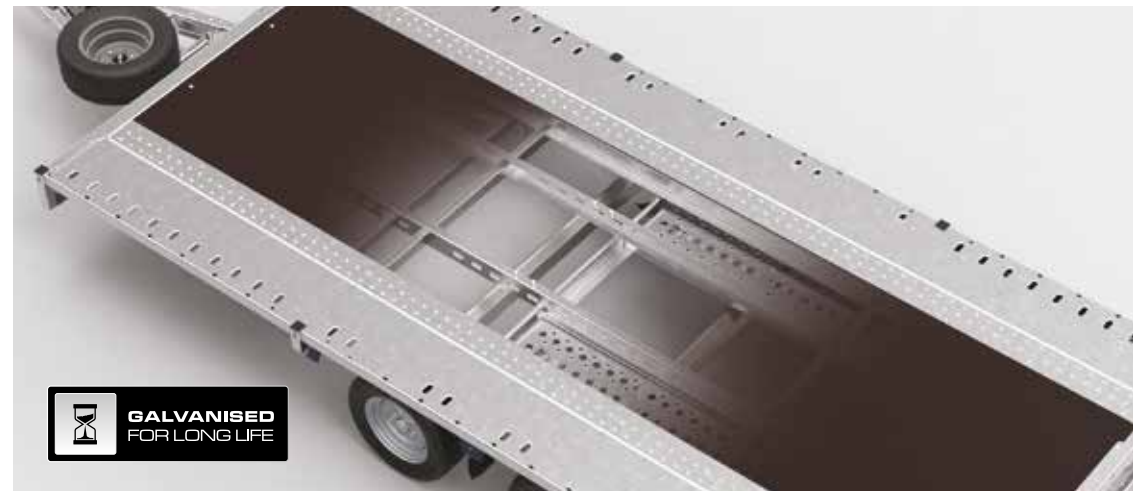

● **Super-Structure**

The strength of CarGO Connect is more than skin deep. Super-strength steel used in the main chassis fabrication is complemented by two additional longitudinal beams just below the 18mm thick phenol ply anti-slip centre bed. Lighter weight and improved strength, combined with the durability of a hot-dip galvanised chassis will be a part of the CarGO Connect for many years.

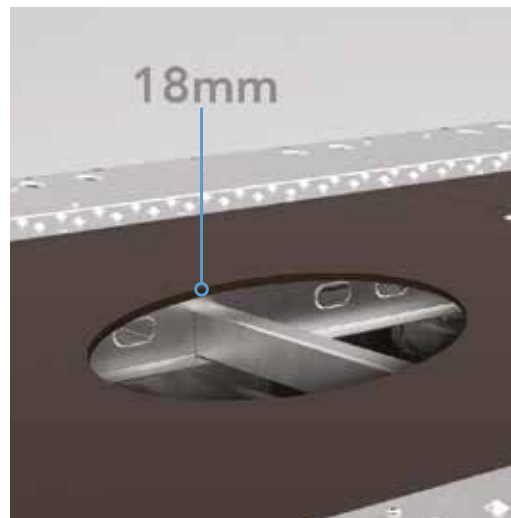

● **Super-Strong**

An 18mm anti-slip phenol ply-deck with a network of chassis supports ensures that heavy items can be transported.

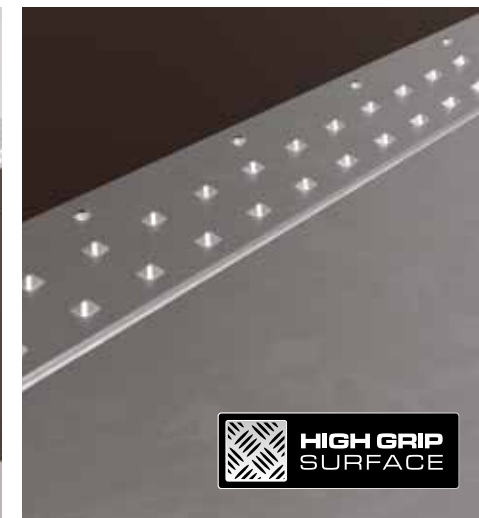

● **Punched steel grip deck**

Forming a permanent raised profile in two tracks this feature provides permanent grip for wheeled vehicles.

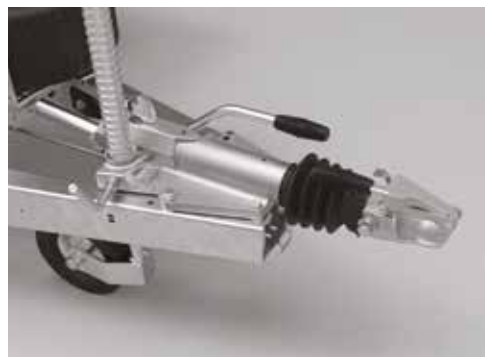

● **Level ride**

Models featuring larger wheels are fitted with a lowered overrun housing draw bar, ensuring that the tow ball is matched to the optimum height for level towing.

SIDE OPTIONS

DROP SIDES, retain loads.

The most useful and popular option for any multi-use trailer is a set of drop sides. The CarGO Connect side options list goes further than ever, with strong, but light steel sides featuring a robust latching mechanism designed to keep sides totally silent. In addition these can be extended with mesh panels, or even a double height option.



○ Drop sides, single height

Featuring a removable headboard, a full set of 0.30m high side panels and securing posts. Panels and posts are fully removable without the need for tools. Every part is designed to last.



○ Front headboard

This strong and practical headboard is fully and easily removable. Especially useful for transporting long loads.

○ Double height, removable sides

'Click and Connect' design allows for an extra set of sides to be fitted directly on-top of a single height side.

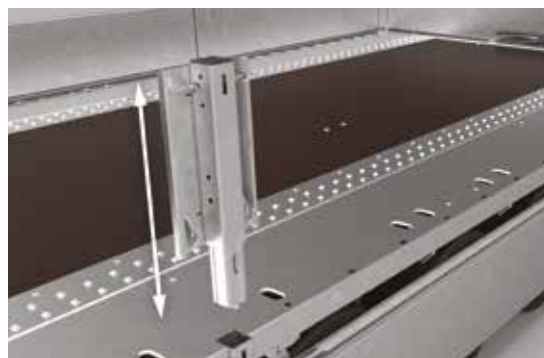

● Toggle catches

Fail-safe, quick release latches. Each latch has its own self adjustment spring to ensure a safe and secure connection.

○ Corner & centre posts

Fitted and removed in seconds and yet extremely robust. Interchangeable posts also ensures re-fitting is uncomplicated.



● Flush deck

The CarGO Connect chassis / body design provides the perfect design for forklift loading.

SIDE OPTIONS

MESH EXTENSIONS, light, strong and useful.

○ Mesh side extensions

Specifically designed for light weight and therefore easy handling, these mesh panels will transform the CarGO Connect's ability to transport bulky, lighter items. With a mesh panel kit the sides are extended by 0.72m and when combined with drop sides, totals 1.02m.



○ Mesh sides, standalone

For the first time CarGO Connect offers the flexibility to configure mesh sides as a standalone feature*, requiring no drop sides to be fitted. This will suit the transportation of scrub and brush materials in site clearance or maintenance operations.



○ Long mesh ramp with high mesh side extensions

Combining long tail ramp, single height drop sides and high mesh side extensions makes an ideal solution for the varied requirements of many landscaping operations.

*Standalone mesh side panels are not available in combination with a tail ramp.

OPTIONS

LOADING, make the complex, simple.

○ Combination, tilt-bed and loading ramps

To provide for any eventuality CarGO Connect can be configured with the ultimate in low loading equipment. Combine the benefits of a hydraulic tilt-bed and the advantages of long loading ramps to provide loading angles as low as 5 degrees.



○ Loading ramps

Choose between 1.80m and 2.35m loading ramps to suit your loading angle requirements. Ramps can be used on both flat-bed or tilt-bed operation trailers.

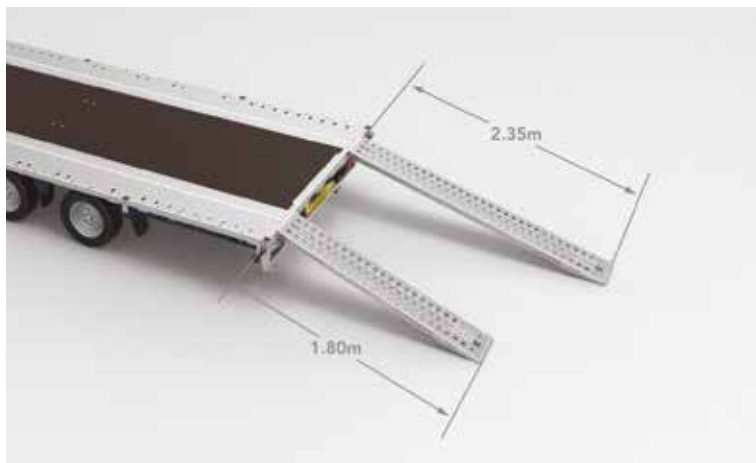

○ Rear support stands

Specify rear stands on flat-bed trailers to provide support when loading heavy equipment from the rear.



○ Long mesh ramp

A full width, long mesh ramp (1.8m long) offers ultimate convenience for flat-bed loading. It can also be combined with a hydraulic tilt operation to make a simple and very low loading facility.



○ Hydraulic tilt-bed

Powerful self-contained hydraulic ram powers the tilt-bed operation. Choose your ideal loading ramp solution to go with it.



○ High grip, full width tail ramp

A high strength, easy ramp solution for tilt-bed operation trailers (formed holes for super grip, see below). Spring assisted for low lifting effort.

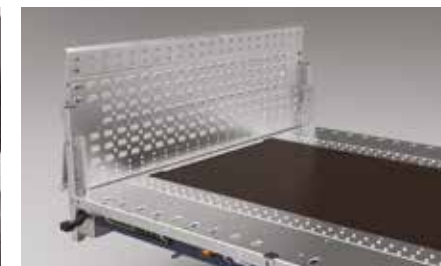

○ High grip, full width tail ramp

Features high strength punched and formed steel. Provides lots of grip and is extremely resistant to wear, even on tough jobs. Hydraulic tilt-bed, plus steel tail ramp combination makes a 12.5° loading angle

OPTIONS

ACCESSORIES, make the most of what you now have.



○ Ladder racks
A configurable ladder rack system gives options to add a ladder rack to a mesh kit, or have it standalone (shown left). Several racks can also now provide a unique option for various purposes (see below).



○ In-deck storage facility
Keep your straps and tools in a convenient place. Latch release catch (not locking).



○ Manual winch, with centre pull
A manual winch with auto-brake and a removable handle for free-spool release of the cable. The centrally located and articulated pulley block ensures every loading operation runs smoothly.



○ Aluminium deck overlay
Compliments the standard high grip steel deck, and protects the 18mm ply decking from severely abrasive environments.



○ Electric winch, 12v high capacity
Electric winch, mounted inboard as shown is powered by a standalone 12v power pack, available separately. Full remote control operation with free spool and roller guides.

○ Full width wheel / machinery chock
Quickly repositioned to suit varying loads or vehicles. Fitting positions are provided right along the full length of each trailer.

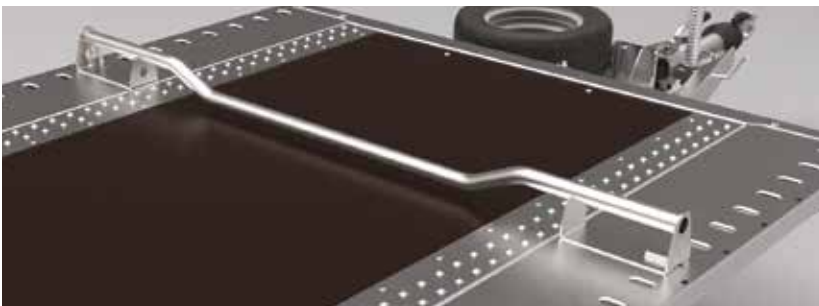

○ Full LED lighting
LED lights are both super bright and reliable. 8 x individual rear lamps are replaced with LED items. All other original lamps are LED technology as standard.

LED lamps: Note
LED lamps are not compatible with all towing vehicles. This may cause unintended consequences. Please check compatibility. A mix of filament and LED lamps is possible.



CARGO CONNECT

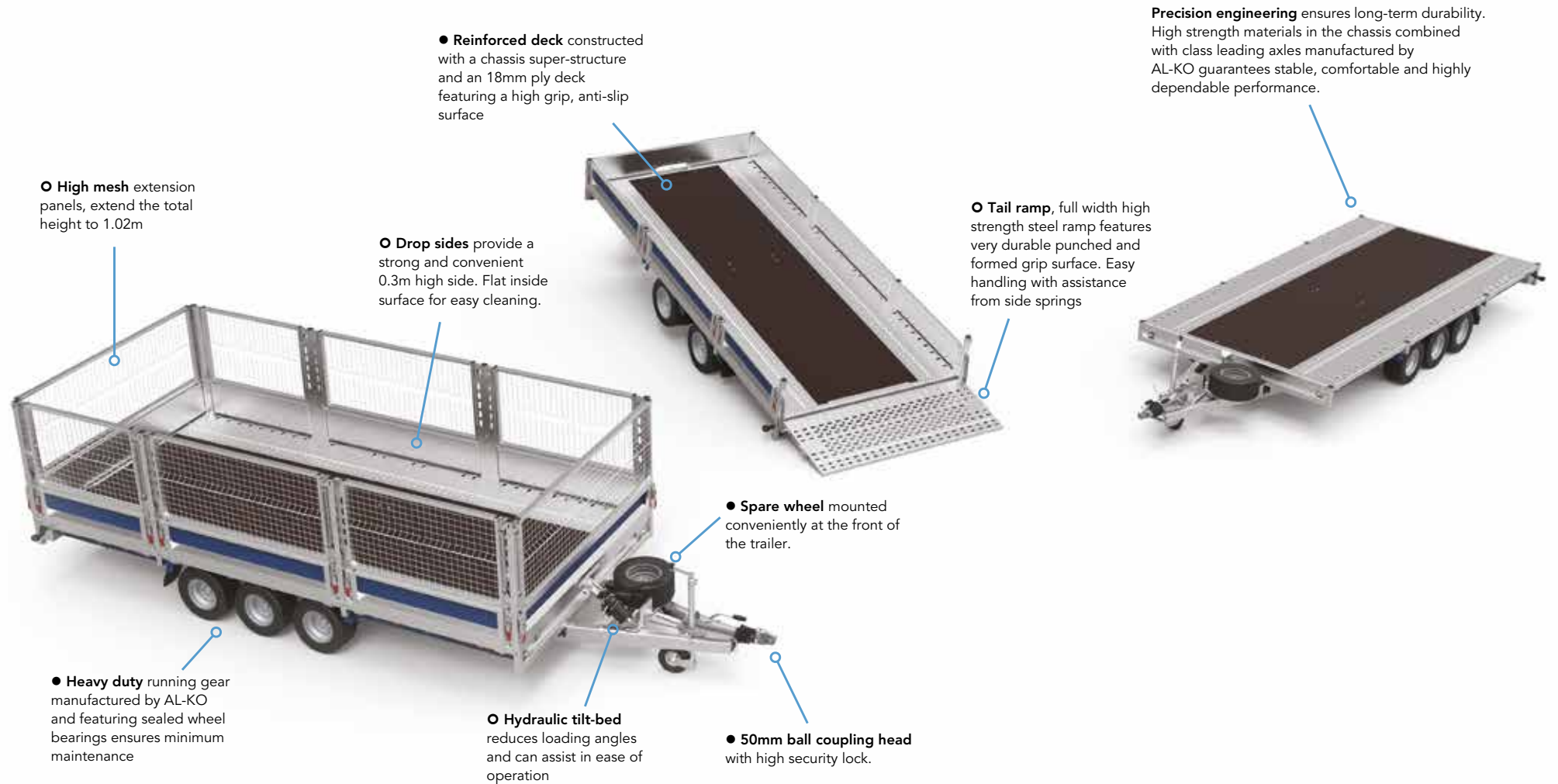

TECHNICAL INFORMATION.

LOAD BED LENGTH m A	4,00		4,50		5,00						5,50					
CAPACITY																
Gross kg	3,500	3,500	3,500	3,500	3,500	3,500	3,500	3,500	3,500	3,500	3,500	3,500	3,500	3,500	3,500	
DIMENSIONS																
Internal bed width m B	2,02	2,02	2,02	2,02	2,17	2,02	2,17	2,02	2,17	2,02	2,17	2,02	2,17	2,02	2,17	
Overall bed width m	2,13	2,13	2,13	2,13	2,28	2,13	2,28	2,13	2,28	2,13	2,28	2,13	2,28	2,13	2,28	
Overall trailer length m	5,54	6,04	6,04	6,54	6,54	6,54	6,54	6,54	6,54	7,04	7,04	7,04	7,04	7,04	7,04	
Bed load height m	0,60	0,60	0,55	0,60	0,60	0,55	0,55	0,60	0,60	0,60	0,60	0,55	0,55	0,60	0,60	
Tow-ball height (loaded) m	0,39	0,39	0,39	0,39	0,39	0,39	0,39	0,39	0,39	0,39	0,39	0,39	0,39	0,39	0,39	
RUNNING GEAR																
Axles	2	2	3	2	2	3	3	3	3	2	2	3	3	3	3	
Wheel / Tyre size	12" (195/60)	12" (195/60)	10" (195/55)	12" (195/60)	12" (195/60)	10" (195/55)	10" (195/55)	12" (195/60)	12" (195/60)	12" (195/60)	12" (195/60)	10" (195/55)	10" (195/55)	12" (195/60)	12" (195/60)	
Spare wheel	●	●	●	●	●	●	●	●	●	●	●	●	●	●	●	
BED OVERLAY																
Aluminium tread plate deck overlay. Fits between steel chassis, covers wooden sections to provide durable surface.	○	○	○	○	○	○	○	○	○	○	○	○	○	○	○	
HYDRAULICS																
Hydraulic tilt-bed operation	—	○	○	○	○	○	○	○	○	○	○	○	○	○	○	
Tail ramp – tilt-bed	—	○	○	○	○	○	○	○	○	○	○	○	○	○	○	
REAR LOADING																
Loading ramps, 1,80m	○	○	○	○	○	○	○	○	○	○	○	○	○	○	○	
Loading ramps, 2,35m	○	○	○	○	○	○	○	○	○	○	○	○	○	○	○	
Loading supports, kick down legs	○	○	○	○	○	○	○	○	○	○	○	○	○	○	○	
Loading ramp, full width, long mesh	○	○	○	○	○	○	○	○	○	○	○	○	○	○	○	
DROP SIDES, SIDE OPTIONS																
Headboard, removable	○	○	○	○	○	○	○	○	○	○	○	○	○	○	○	
Connect drop side system – removable headboard, and drop sides (0.3m)	○	○	○	○	○	○	○	○	○	○	○	○	○	○	○	
Connect extended side, double height – removable headboard, and drop sides (+0.3m)	○	○	○	○	○	○	○	○	○	○	○	○	○	○	○	
Connect extended side, mesh kit (+0.72m)	○	○	○	○	○	○	○	○	○	○	○	○	○	○	○	
Ladder rack	○	○	○	○	○	○	○	○	○	○	○	○	○	○	○	
WINCH																
Man auto winch kit, includes cable and pulley	○	○	○	○	○	○	○	○	○	○	○	○	○	○	○	
Electric winch kit, includes fair-lead + remote, no power	○	○	○	○	○	○	○	○	○	○	○	○	○	○	○	
Electric winch, 12v portable, pro-power pack	○	○	○	○	○	○	○	○	○	○	○	○	○	○	○	
ACCESSORIES, LIGHTING																
Loading assist, full width wheel chock	○	○	○	○	○	○	○	○	○	○	○	○	○	○	○	
Storage tray, below bed location, deck board lid	○	○	○	○	○	○	○	○	○	○	○	○	○	○	○	
LED lighting, full rear lighting kit, multi-voltage	○	○	○	○	○	○	○	○	○	○	○	○	○	○	○	
PRODUCTS																
Product code	475-3442	475-4442	475-4452	475-5442	475-5443	475-5452	475-5453	475-5462	475-5463	475-6442	475-6443	475-6452	475-6453	475-6462	475-6463	

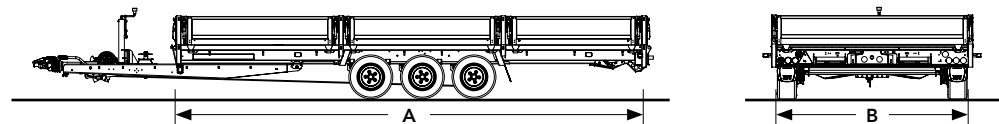





QUALITY

Brian James Trailers are manufacturers of class leading trailers, since 1979. When you buy a Brian James Trailer you can be absolutely certain that it is designed and constructed to the highest possible standards. Our Engineers combine top-quality craftsmanship with the best materials and first-class presentation. Light but strong, our trailers are crafted to enhance safety, efficiency and durability.

5 Year Chassis Warranty

This Brian James Trailer is provided to you with a non-transferable manufacturers warranty covering the integrity of the chassis for a period of 5 years from the date of first registration.

We warrant that under normal use, outside of accident damage or misuse (meaning driven across unsuitable territory or being overloaded) the chassis will not fatigue or fail to be able to perform its intended duties safely.

Any repair or rectification as a result of a claim under this warranty will be at Brian James Trailers cost and be carried out either at a Brian James Trailers main dealer, or at the factory HQ in Daventry, UK, at the discretion of Brian James Trailers Ltd. A repair may involve removal of the original galvanised surface finish, for which we will not liable to reinstate to its original state.

Brian James Trailers will not be liable for any consequential loss in connection with a claim on this warranty, including recovery fees or transport to or from the place of final repair.

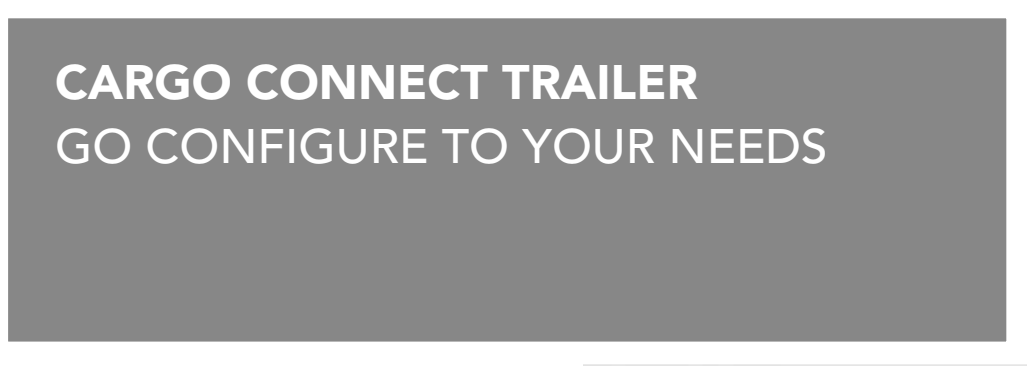
A graphic with a red square containing a white number '5' on the left, and a black rectangle with the text '5 YEAR CHASSIS WARRANTY' in white on the right.A dark grey rectangular box with the text 'CARGO CONNECT TRAILER' and 'GO CONFIGURE TO YOUR NEEDS' in white, stacked vertically.



NOTES

Specifications are subject to change without notice.
Illustrations and photography may depict optional equipment.

www.brianjames.co.uk

© BRIAN JAMES TRAILERS LIMITED.
Printed in the UK.

Edition CARGOCON2016_Q3_1

Brian James Trailers Limited.
Sopwith Way, Drayton Fields Industrial Estate
Daventry, Northampton, NN11 8PB

T + 44 (0)1327 308 833

Brian James Trailers are available by contacting our sales team as well as through an extensive network of official dealers throughout the country.

For more information please call or visit our website.

www.brianjames.co.uk

Dealer information.

